



TEL/FAX.: (514) 328-7499
TOLL FREE: (844) 488-7499 (USA/CANADA)
EMAIL: support@vpixx.com
www.vpixx.com



PROPiXX Full (VPX-PRO-5001C)

PROPiXX Lite (VPX-PRO-5000A)

User Manual

Version 1.1



Vision Science Solutions

www.vpixx.com

IMPORTANT

VPixx Technologies Inc. reserves the right to modify or otherwise update this document without notice as required by a constantly evolving marketplace, client requests or to adapt to new progress or constraints in engineering or manufacturing technology. The information contained in this document may change without prior notice.

No part of the written material accompanying this product may be copied or reproduced in any form, in an electric retrieval system or otherwise, without prior written consent of VPixx Technologies Inc.

Product/company names mentioned in this document are the trademarks of their respective owners.

VIEWPixx, *DATAPixx*, *PROPixx*, are registered Trademarks of VPixx Technologies Inc.

For more information about our company and products, visit our Web site at www.vpixx.com

For information, comments or suggestions, please contact us by e-mail at support@vpixx.com

Our offices are located at:

**630 Clairevue West suite 301
Saint-Bruno, Qc
Canada, J3V 6B4**

Version History of this document

Version Updated to	Date	Author	Reason
1.0	2014/10/30	P.Kakos	v1.0 release
1.1	2016/11/01	P.Kakos	new pictures

Document Icons

The use of icons emphasizes helpful, caution or warning notes. Below is a list of the available icons.



Icon	Type	Description
	Helpful Hint	<i>Information to help out during assembly, installation or usage</i>
	Caution Notice	<i>Important Information to prevent misuse and/or damage to equipment</i>
	Warning	<i>Critical information to prevent damage to equipment and/or personnel</i>

Table of Contents

Table of Contents	2
Table of Tables	4
Table of Figures.....	4
Overview.....	6
WARNING - SAFETY INFORMATION.....	6
Compliance Information.....	7
For European Countries.....	7
For the United States of America	8
For Canada.....	8
Declaration of RoHS Compliance.....	8
System Overview	9
Front view of projector and controller.....	9
Rear view of projector.....	10
Rear view of controller	10
General specifications	11
Video processing.....	11
Analog to digital converter	11
Digital to analog converter	12
Audio CODEC	12
Digital input	12
Digital output.....	12
Power (projector unit).....	12
Power (controller unit)	12
Mechanical mounting (projector unit)	13
Software	13
Hardware and software requirements.....	14
Graphics Card.....	14
USB 2.0.....	14
Operating System	14
PROPixx installation.....	15
Screen size vs throw distance.....	16

Mounting the projector	17
Ceiling mount.....	17
Level adjustment	18
Stacking projectors	18
Shifting the image.....	18
Adjusting the lens	20
Zoom.....	20
Focus.....	20
Cable installation	20
Powering the device	23
Device detection.....	23
Status LED	23
Remote controller.....	24
Inserting batteries into the remote control	24
Installation test pattern.....	24
Software Installation Instructions for Mac OS X.....	25
Driver and Software Installation Instructions for Windows.....	25
I/O connector descriptions.....	26
Analog I/O connector	26
VESA 3D connector	26
Digital output connector	27
Digital input connector.....	27
Audio In / MIC In / Audio Out.....	28
Theory of operation.....	29
Video Pipeline.....	29
Video and I/O synchronization	29
DVI Out	29
Analog output interface.....	29
Analog input interface	30
Digital interface	30
Audio interface	30
LED light source	31

Software support.....	32
Psychtoolbox.....	32
Python.....	33
Low-level ANSI C API.....	33
PROPixx firmware update.....	34
vputil Software Tool	35
Maintenance and Calibration	36
Calibrating the PROPixx.....	36
Warranty.....	37

Table of Tables

TABLE 1 STATUS LEADS.....	23
TABLE 2 REMOTE CONTROLLER BUTTONS	24
TABLE 3 ANALOG I/O	26
TABLE 4 VESA 3D	26
TABLE 5 DIGITAL OUTPUT	27
TABLE 6 DIGITAL INPUT.....	27
TABLE 7 AUDIO IN	28
TABLE 8 AUDIO OUT.....	28
TABLE 9 MIC IN.....	28

Table of Figures

FIGURE 1 FRONT VIEW OF CONTROLLER AND PROJECTOR	9
FIGURE 2 REAR VIEW OF PROJECTOR.....	10
FIGURE 3 REAR VIEW OF CONTROLLER	10
FIGURE 4 SCREEN SIZE VS THROW DISTANCE	16
FIGURE 5 ADJUSTABLE FEET	17
FIGURE 6 M4 MOUNTING HOLES	17
FIGURE 7 SLIDING OFF NAME PLATE	18
FIGURE 8 HORIZONTAL AND VERTICAL ADJUSTMENT CONTROLS.....	19
FIGURE 9 IMAGE SHIFT LIMITS	19
FIGURE 10 USB CABLE BETWEEN PROJECTOR AND COMPUTER.....	20
FIGURE 11 USB CABLE BETWEEN CONTROLLER AND COMPUTER	20

FIGURE 12 DVI CABLE BETWEEN PROJECTOR AND CONTROLLER.....21

FIGURE 13 DVI CABLE BETWEEN CONTROLLER AND COMPUTER21

FIGURE 14 AC ADAPTOR CONNECTED TO PROJECTOR’S DC-IN CONNECTOR.....22

FIGURE 15 AC ADAPTOR CONNECTED TO CONTROLLER’S DC-IN CONNECTOR22

FIGURE 16 REMOTE CONTROLLER.....24

FIGURE 17 REMOTE CONTROLLER BATTERY INSTALLATION24

FIGURE 18 VPIXX TOOLS SETUP WIZARD25

FIGURE 19 CIE 1931 COLOR SPACE DIAGRAM.....31

FIGURE 20 VPUTIL APPLICATION MAIN SCREEN35

Overview

This manual provides installation, usage and maintenance information for VPixx Technologies Inc.'s PROPixx system.

For technical questions or product support information, do not hesitate to contact the VPixx support team by sending an E-mail at support@vpixx.com or by phone.



By creating your *MyVPixx* account on the VPixx Technologies website, you will have access to additional product documentation, demos, source code examples and the latest firmware and software drivers.

WARNING - SAFETY INFORMATION

- Do not open the cabinet. There are no user serviceable parts inside.
- Use only the power cable included with the PROPixx.
- Ensure that the power outlet includes a Ground connection, as this equipment MUST be grounded.
- Do not expose the projector to rain or moisture, and do not place any liquids on top of the projector.
- Unplug before cleaning. When cleaning, use a damp (not wet) cloth.
- Handle the power cable carefully and avoid sharp bends. Do not use a damaged power cable.
- Do not cover or obstruct the ventilation outlets or inlets.
- Never use strong detergents or solvents such as alcohol or thinners to clean the projector and lens.



Never cover the lens while the projector is switched on. This could pose a fire hazard.

Compliance Information

For European Countries



DECLARATION OF CONFORMITY

Manufacturer's Name: VPixx Technologies Inc.

Manufacturer's Address: 630 Clairevue West suite 301
Saint-Bruno, Qc
Canada, J3V 6B4

Product Name: PROPixx and PROPixx Lite

Part Numbers: VPX-PRO-5001C, VPX-PRO-5000A

Product Options : All

Application of Council Directive:

2004/108/EC	-Electromagnetic Compatibility directive
2006/95/EC	-Low Voltage directive
2002/95/EC	-RoHS directive
2012/19/EU	-Waste Electrical and Electronic Equipment directive

The following harmonised standards have been used:

EN 61326-1:2013	-Electrical equipment for measurement, control and laboratory use.
• IEC CISPR 11	-Radio frequency disturbance characteristics (Class A)
• IEC 61000-3-2	-Limits for harmonic current emissions (Class D)
• IEC 61000-3-3	-Limitation of voltage changes, voltage flicker ($\leq 16A$ per phase)
• IEC 61000-4-2	-Electrostatic discharge immunity test (Level 2 contact, air) (Perf Criteria B)
• IEC 61000-4-3	-Radiated, radio-frequency, electromagnetic field immunity test (Level 2, Perf Criteria A)
• IEC 61000-4-4	-Electrical fast transient/burst immunity test (Level 2, Perf Criteria B)
• IEC 61000-4-5	-Surge immunity test (Level 2, Perf Criteria B)
• IEC 61000-4-6	-Immunity to conducted disturbances, induced by radio-frequency fields (Level 2, Perf Criteria A)
• IEC 61000-4-8	-Power frequency magnetic field immunity test (Level 2, Perf Criteria A)
• IEC 61000-4-11	-Voltage dips, short interruptions and voltage variations immunity tests (Perf Criteria B and C)

Supplementary Information:

To remain CE compliant, only CE compliant parts should be used with this product. Maintaining CE compliance also requires proper cable and cabling techniques. VPixx Technologies will not retest systems or components that have been modified by customers.

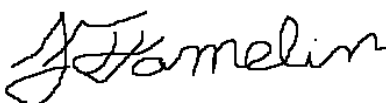
Signature: 

Printed name: Jean-François Hamelin, Eng

Title: Vice President



The following information is only for EU member states:



The mark shown to the left is in compliance with the Waste Electrical and Electronic Equipment directive 2012/19/EU (WEEE). The mark indicates the requirement NOT to dispose of the equipment as unsorted municipal waste. For more information call VPixx Technologies Inc. or email us at support@vpixx.com

For the United States of America

This device complies with part 15 subpart B of FCC rules. Its operation is subject to the following two conditions: (1) this device may not cause harmful interference, and (2) this device must accept any interference received, including interference that may cause undesired operation. This equipment has been tested and found to comply with the limits for a Class A digital device, pursuant to part 15 subpart B of the FCC rules.

For Canada

This Class A digital apparatus complies with Canadian ICES-003.

Declaration of RoHS Compliance

RoHS This product has been designed and manufactured in compliance with Directive 2002/95/EC of the European Parliament and the Council on restriction of the use of certain hazardous substances in electrical and electronic equipment (RoHS Directive).

System Overview

The PROPixx is a unique DLP LED projector designed to be the most flexible display possible for vision research. It features a native resolution of 1920 x 1080 and can be driven with refresh rates up to 500 Hz (RGB mode) or 1440 Hz (Greyscale mode) with deterministic timing.

The PROPixx uses high brightness LEDs as a light source, giving a larger color gamut and much longer lifetime than halogen light sources (60,000 hrs vs 2,000 hrs). The LEDs also support high bit depth and high frequency full color stimulation which would not be possible with a color-wheel/halogen architecture. For stereo vision applications, our high speed circular polarizer can project stereoscopic stimuli for passive polarizing glasses at up to 400 Hz.

The PROPixx comes equipped with an array of peripherals which often need to be synchronized to video during an experiment. These peripherals include a stereo audio stimulator, a button box port for precise reaction-time measurement, triggers for electrophysiology and eye-tracking equipment, and even a complete analog I/O subsystem. You can now successfully synchronize all of your subject I/Os to video refresh with microsecond precision.

The PROPixx is available with multiple projection lens options including short-throw lenses for CRT replacement applications, and long-throw lenses for MRI/MEG applications.

The PROPixx system is made up of two distinct components; the controller and the projector unit.

Front view of projector and controller

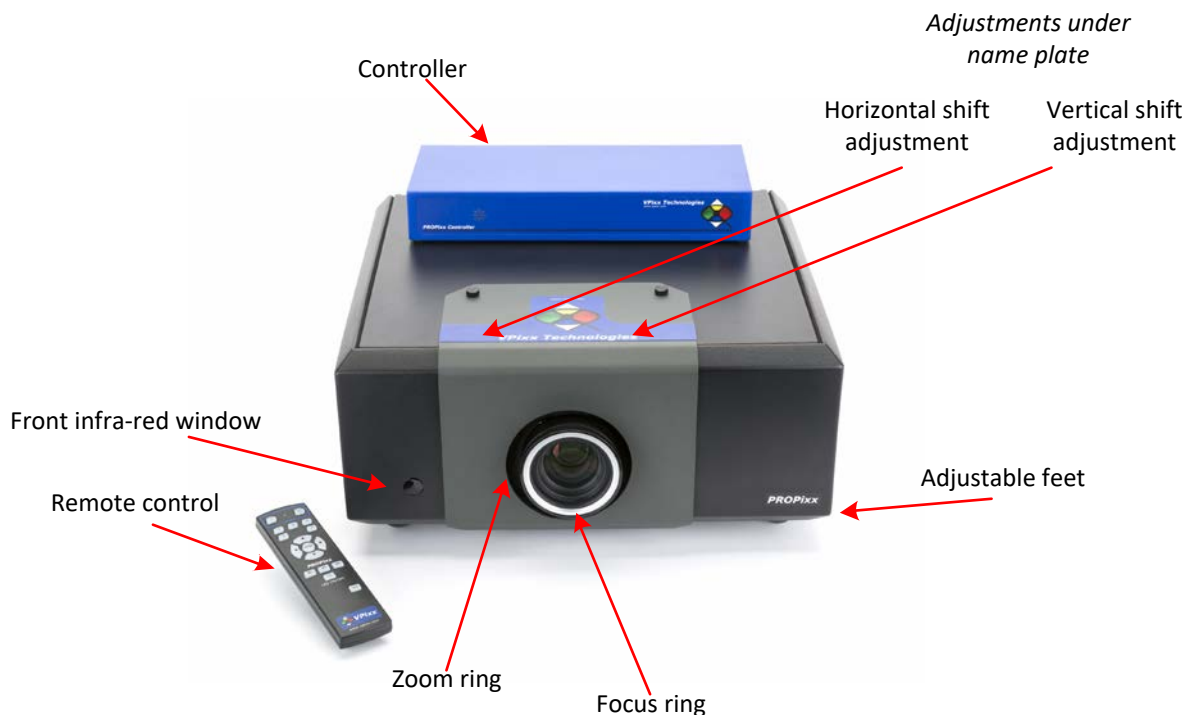

Figure 1 Front view of controller and projector

Rear view of projector

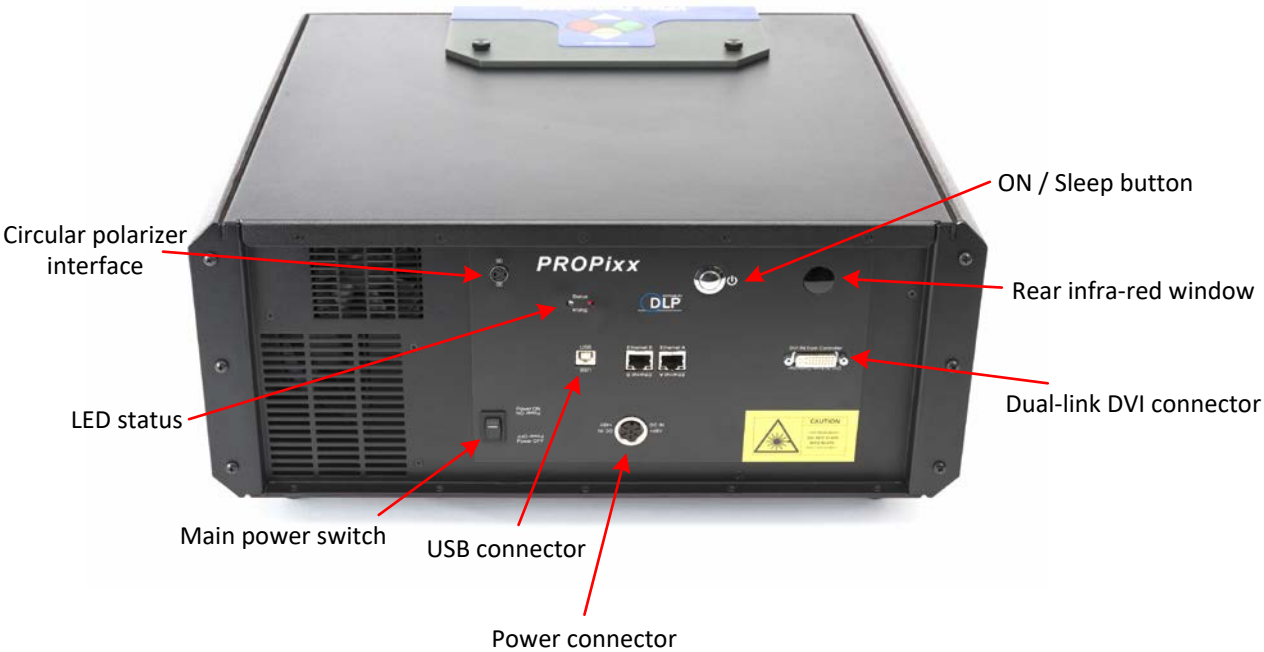

Figure 2 rear view of projector

Rear view of controller

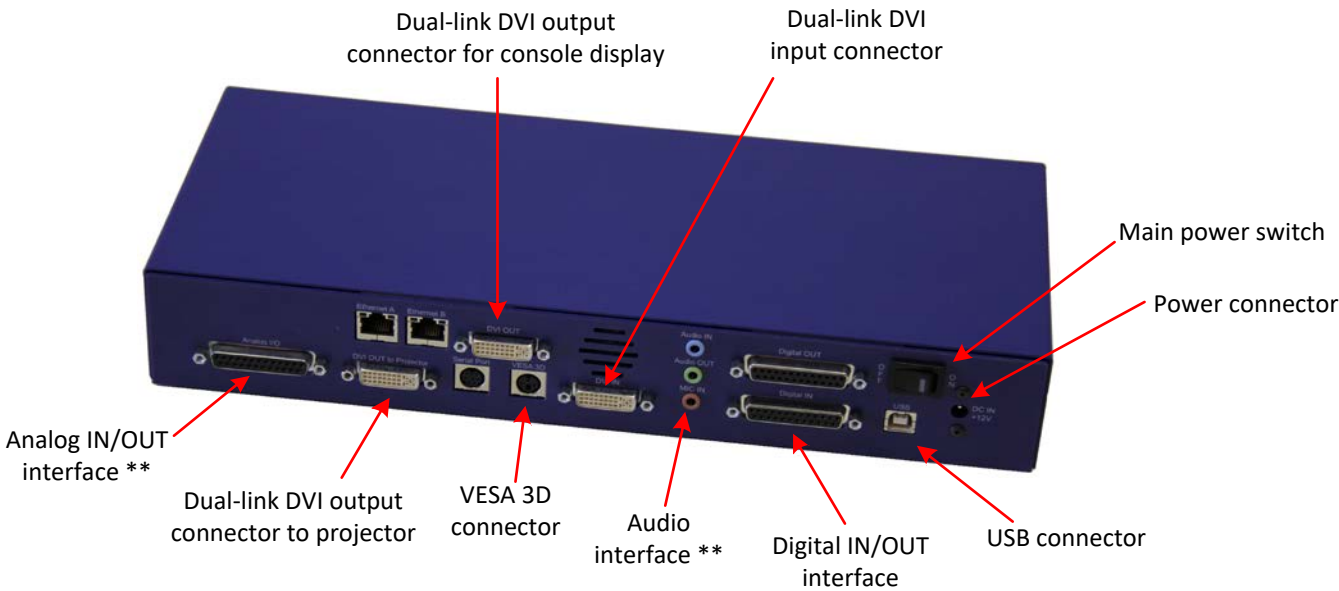

Figure 3 Rear view of controller

**Analog I/O and audio functionalities are available only with PROPixx full version (VPX-PRO-5001C)

General specifications

- Display resolution: 1920(H) x 1080(V) pixels
- Display type: Texas Instruments DMD 0.95"
- Aspect ratio: 16x9
- Illumination system: RGB LED
- Contrast: 10 000:1
- Brightness: 700 lumens
- Lamp life: 60 000 hours via solid state illumination
- Up to 12 bits of resolution on each of the RGB channels
- Up to 500 Hz refresh rate (RGB color)
- Up to 1440 Hz refresh rate (Greyscale)
- IR remote control

Video processing

- Video input: 1920 x 1080 pixels, 24 bits (Dual link DVI)
- Deterministic timing between reception of video signal and update of display pixels
- Completely bypasses all image processing “enhancements” prevalent in standard consumer projectors
- Multiple projectors can be synchronized, showing copies or subsets of original video

Analog to digital converter

- Number of channels: 16 (or 8 differential), on DB-25 connector
- Converter resolution: 16 bits
- Maximum sampling rate: 200 kSPS per channel
- Frequency programming modes:
 - Samples per second
 - Samples per video frame
 - Nanoseconds per sample
- Simultaneous sampling across all channels
- Input range: ± 10 V
- Input impedance: $1.6 \cdot 10^8 \Omega // 3$ pF
- Absolute maximum input tolerance: ± 12 V

*ADC functionalities are available only with PROPixx full version (VPX-PRO-5001C)

Digital to analog converter

- Number of channels: 4 on DB-25 connector
- Converter resolution: 16 bits
- Maximum sampling rate: 1 MSPS per channel
- Frequency programming modes:
 - Samples per second
 - Samples per video frame
 - Nanoseconds per sample
- Simultaneous output updates
- Output range: ± 10 V
- Drive capability: ± 25 mA, 250 mW per channel

*DAC functionalities are available only with PROPixx full version (VPX-PRO-5001C)

Audio CODEC

- Audio line in, microphone in, speaker out, on 3.5 mm jacks
- Stereo microphone input amplifier resistance: 20 k Ω
- Microphone sampling rate: 96 kHz
- Programmable microphone bias voltage range: 2.0 V to 3.1 V
- Stereo DAC sampling rate 96 kHz

*Audio CODEC functionalities are available only with PROPixx full version (VPX-PRO-5001C)

Digital input

- Number of digital inputs: 24 on db-25 connector
- Input termination: >20 k Ω pullup to 3.3 V
- Input tolerance: 5 V

Digital output

- Number of digital outputs: 24 on db-25 connector
- Output drive stage: 5 V through 25 Ω series resistor
- Maximum output current:
 - Source: 15 mA
 - Sink: 12 mA

Power (projector unit)

- Power consumption: 250 W
- Input voltage: 48 VDC – 5.21 A
- International AC adaptor input: 90 VAC – 264 VAC (47 Hz – 63 Hz)

Power (controller unit)

- Power consumption: 30 W
- Input voltage: 12 VDC – 2.5 A
- International AC adaptor input: 90 VAC – 264 VAC (47 Hz – 63 Hz)

Mechanical mounting (projector unit)

- Front/rear table
- Front/rear ceiling

Software

Software support includes a low-level ANSI C API as well as Psychtoolbox MATLAB / Octave and Python libraries for Mac OS X, Windows XP, Windows 7, Windows 8 and Linux. In addition, the PROPixx is directly supported by the VPixx high-level application.

Hardware and software requirements

Graphics Card

The graphics card should have dual-link DVI outputs, or DisplayPort/Thunderbolt outputs (which can be converted to dual-link DVI through an active dongle).



All DisplayPort adaptors are not created equal. The limitation is the 320 MHz video bandwidth which your graphics board can transmit over a dual-link DVI video cable. This is enough bandwidth to generate a full 1920x1200 (or 1080) image at 120 Hz.

We strongly recommend using the following adaptor, which can be obtained from VPixx Technologies or ACCEL Cables.

<http://www.accellcables.com/collections/adapters/products/ultraav-displayport-or-mini-displayport-to-dvi-d-dual-link-adaptor-with-3d-support>

USB 2.0

The host computer requires at least one USB 2.0 interface.

Operating System

The PROPixx is compatible with the following OS: MAC OS X, Windows XP (32bit, 64bit), Windows 7 (32bit, 64bit), Windows 8 (32bit, 64bit) and Linux.

PROPixx installation

You will need a flat, stable area to install your PROPixx. Also, familiarize yourself with the following simple guidelines concerning the installation of your PROPixx system.

- The projector should be installed as close to the power outlet as possible.
- The power connection should be easily accessible, so that it can be disconnected in an emergency.
- Ensure that there is at least 30 cm (12 in) of space between the ventilation outlets and any wall, and 10 cm (4 in) of space for all other sides.
- Do not install the projector close to anything that might be affected by its operational heat (polystyrene ceiling tiles, curtains, etc.)
- When stacking projectors, the stack **MUST** be vertical, to ensure that the stresses are distributed to all four chassis corners.
- Do not place heavy objects on top of the projector chassis. Only the chassis corners are capable of withstanding the weight of another projector.
- Do not drop or knock the projector.
- Place the projector in a dry area away from sources of dust, moisture, steam, smoke, sunlight or heat.



The projector weighs approximately 15 kg (33 lbs). Use safe handling techniques when lifting the projector. Backup safety chains or wires should always be used with ceiling mount installations.



Never cover the lens while the projector is switched on. This could pose a fire hazard.

Screen size vs throw distance

The *Throw distance* is the distance measured from the front of the projector to the screen. This is an important consideration when it comes to projector installation as it determines whether or not you have enough room to install your projector with the desired screen size, and if your image will be the right size for your screen.

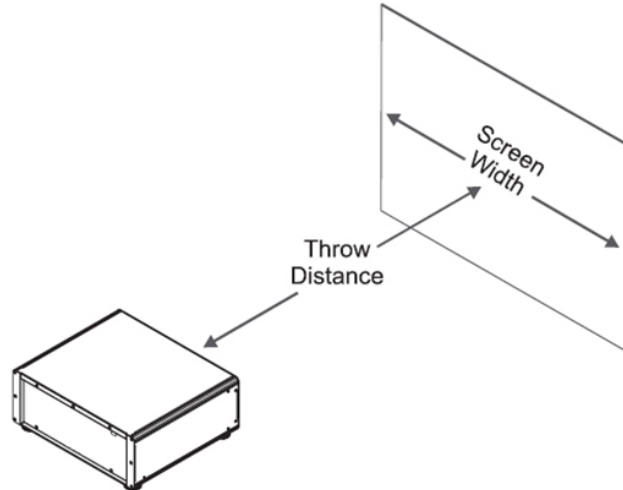

Figure 4 Screen size VS throw distance

Calculating screen width and throw distance

Throw Distance = *Screen Width* * *Lens Throw Ratio*

Screen Width = $\frac{\text{Throw Distance}}{\text{Lens Throw Ratio}}$

The available lenses for the projector have the following optical specifications:

Part Number	Lens Type	Throw Ratio	Focus Range (Metric)	Focus Range (Imperial)
VPX-ACC-6501	Super short-throw lens	0.73 : 1	0.97 - 1.3 m	3.18 - 4.27 ft
VPX-ACC-6502	Short-throw lens	1.56 – 1.86 : 1	1.22 - 7 m	4.0 – 23 ft
VPX-ACC-6503	Long-throw lens	1.85 – 2.40 : 1	1.22 - 10 m	4.0 - 32.0 ft
VPX-ACC-6504	Super long-throw lens	2.4 – 4.0 : 1	1.22 - 12m	4.0 - 39.0 ft
VPX-ACC-6507	Super long-throw lens	8.9 – 14.8 : 1	1.52 - 12.19 m	5.0 – 40.0 ft
VPX-ACC-6508	Super long-throw lens	3.3 – 5.94 : 1	1.22 - 12.19 m	4.0 – 40.0 ft
VPX-ACC-6509	Super long-throw lens	6.3 – 11.0 : 1	1.22 - 12.19 m	4.0 – 40.0 ft

- The focus range is the distance over which the image can be focused using the focus ring.
- The zoom range is the range over which the throw ratio can be changed using the zoom ring.

Mounting the projector

The four adjustable feet under the chassis allow the projector to be lowered onto a flat surface without any danger of hands being trapped between the chassis and the surface.



Figure 5 Adjustable feet

Ceiling mount

The projector is designed to be used on a flat surface, but it can also be suspended from a ceiling if your application requires it. Three M4 mounting holes with a 0.7 mm pitch are provided under the projector to allow bolting to a ceiling mounting plate.



Before installation, make sure that the surface, ceiling or rigging that is to support the projector is capable of supporting the combined weight of all the projectors.

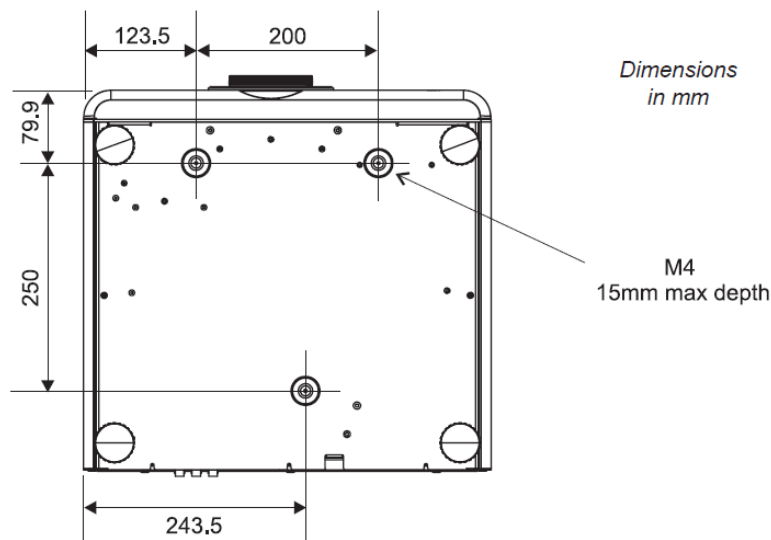

Figure 6 M4 Mounting holes

Level adjustment

If the projector is to be operated from a flat surface such as a projector table, then adjustment of the projector level should be made by turning the four feet under the chassis.

Ideally, the projector should be positioned perpendicular to the screen, and the lens shift controls used to align the image with the screen, to maintain a geometrically correct image.

Stacking projectors

The projector is capable of supporting the weight of **up to three** other projectors safely. The stack should be positioned vertically and perpendicular to the screen. The lens shift controls can be used to align the image with the screen to maintain a geometrically correct image.

- Carefully lower each projector down onto the previous, making sure that they are vertically aligned with each other. Also verify that they are not in an area or position where they can be easily tipped over or pushed.
- Align the images from the projectors using the Lens shift controls (see below).

Shifting the image

Ideally, the projector should be positioned perpendicular to the screen. The normal position for the projector is at the center of the screen. However, you can set the projector above or below the center, or to one side, and adjust the image using the Lens shift controls on the top of the projector to maintain a geometrically correct image.

If the projector is fitted with the fixed 0.73:1 lens then there are no mechanical controls for lens shift.

Remove the front cover the PROPixx.



Figure 7 Front cover

With the name plate removed, use the 5mm Allen wrench to adjust the horizontal and vertical position of the image.

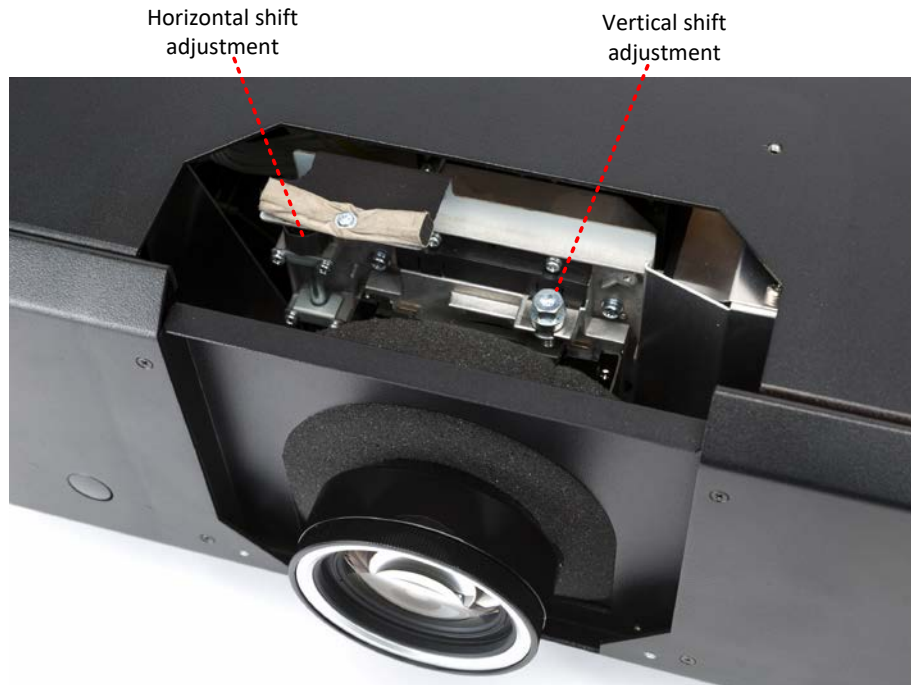

Figure 8 Horizontal and vertical adjustment controls

The image can be shifted by up to:

- ± 0.6 times the height of a full screen image (known as 120% shift)
- ± 0.15 times the width of a full screen image (known as 30%)

It is physically possible to shift the lens further than these limits, but this will result in some distortion of the image beyond the ranges specified above.

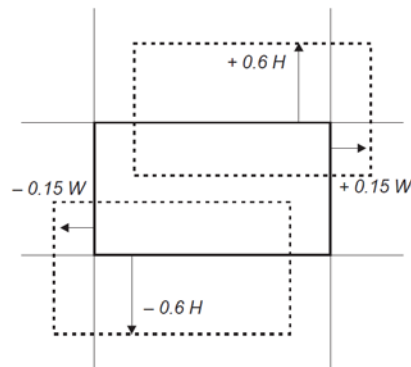

Figure 9 Image shift limits

Adjusting the lens

Zoom

Turn the smooth ring on the lens, closest to the case, to adjust the zoom so that the image fills the screen.

Focus

Turn the knurled ring at the outer end of the lens to adjust the focus until the image is sharp.

Cable installation

1. Connect the USB cable between the projector unit and your computer

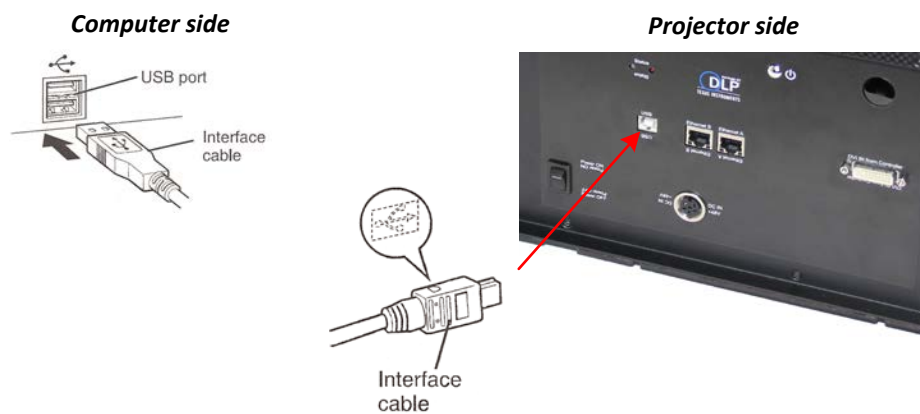

Figure 10 USB cable between projector and computer

2. Connect the USB cable between the controller unit and your computer

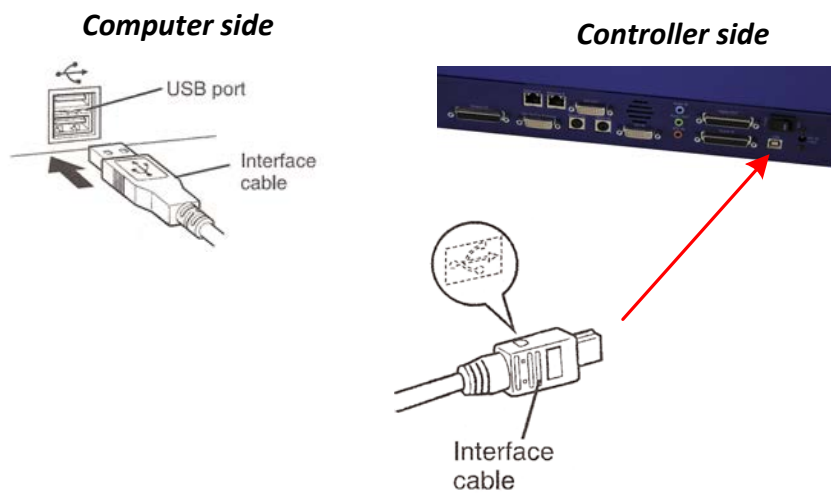

Figure 11 USB cable between controller and computer

3. Connect the DVI cable between the projector and the controller. Be sure to use the *DVI Out to Projector* connector on the controller.



Figure 12 DVI cable between projector and controller

4. Connect the DVI cable between the controller and your computer.

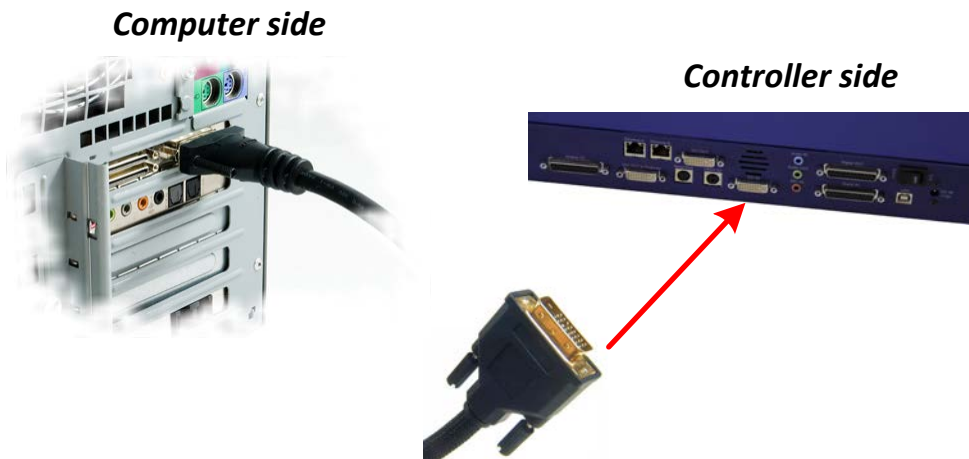

Figure 13 DVI cable between controller and computer

5. Attach the AC adaptor to the projector DC-in connector

Projector side



Figure 14 AC adaptor connected to projector's DC-IN connector

6. Attach the AC adaptor to the controller DC-in connector.



Figure 15 AC adaptor connected to controller's DC-IN connector

Powering the device

Once all cables have been properly connected, you can power on your PROPixx. The power up procedure is as follows:

1. Toggle the controller's power switch to the ON position.
2. On the projector, press the  button once to switch the projector ON.



Pressing the projector's  button continually for 3 seconds or more will put it in SLEEP mode.

Device detection

After toggling the power switch to ON, your computer should detect the projector and controller and perform the necessary installation. On a Mac OS X system, no driver is required; however under Microsoft Windows, a driver must be installed.

Status LED

Your PROPixx is equipped with two status LEDs that supply information on the energy or power status of your system. The information relayed by each LED, one blue and one red, is summarized in the table below.

Table 1 Status LEDs

	ON	Blinking
BLUE LED	Awake Mode	LED Off mode
RED LED	Sleep Mode	Thermal Shutdown

Remote controller

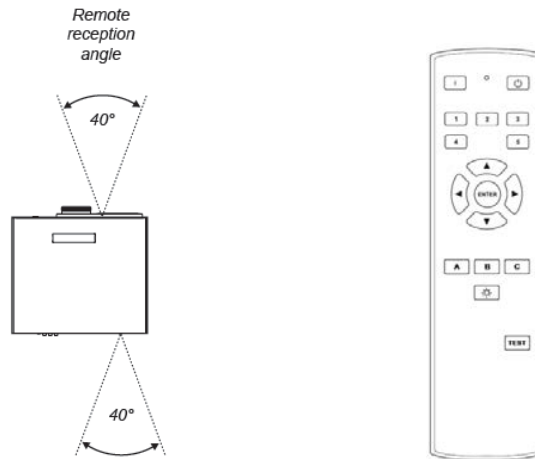

Figure 16 Remote controller

Table 2 Remote controller buttons

Button symbol	Function	Description
	Power ON	Press POWER ON on the remote control to switch the projector ON
	Power OFF	Press POWER OFF on the remote control to switch the projector to SLEEP mode
	LED ON/OFF	Turn ON/OFF LED light source
Other		User defined by software

Inserting batteries into the remote control

Open the battery compartment and insert two AA batteries, ensuring that they are inserted with the orientation shown below.

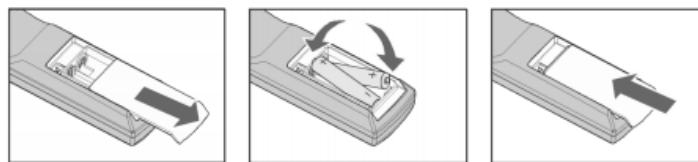

Figure 17 Remote controller battery installation

Installation test pattern

For a perfect installation and screen geometry, you can use your PROPixx projector in *test mode*. To do this, simply press the TEST button followed by the A button on the remote control. You can do this same sequence for tests B and C.

Press the test button twice to return to the normal mode.

Software Installation Instructions for Mac OS X

As a first step, ensure that the PROPixx is turned OFF. Then, insert the CD labeled “**VPixx Technologies Software/Documentation**” in your CD/DVD reader and copy the *Software Tools for MAC* folder into the OS X or Linux user folder.

In the *Software Tools for MAC* folder can be found documentation, drivers, libraries and low level C API. By using the *vputil* application you can configure and operate your device on a basic level.



For more information on VPixx software tools, please refer to the **VPixx Software Tools user manual**.

Driver and Software Installation Instructions for Windows

These instructions are for Windows 7. Installation under Windows Vista, XP or Windows 8 is similar, but not necessarily identical.

As a first step, ensure that the PROPixx is turned OFF. Then, insert the CD labeled “**VPixx Technologies Software/Documentation**” in your CD/DVD reader. In *Software Tools for Windows*, run the *setup.exe* application. When the following box appears, click *Next* and follow the instructions.



Figure 18 VPixx Tools Setup Wizard

When finished, you can toggle the power switch to the ON position and your device is ready for use.

A shortcut of *vputil.exe* is copied on the *Windows desktop* as well as the *Program Files*, in the *VPixx Technologies* folder; documentation, drivers, libraries and low level C API folders are copied. By using the *vputil* application you can configure and operate your device on a basic level.

Once the installation is complete, the *VPixx Technologies* folder is located under *C:\Program Files*



For more information on VPixx software tools, please refer to the **VPixx Software Tools user manual**.

I/O connector descriptions

Analog I/O connector

The following table shows the analog I/O pin assignment. If you use the analog breakout cable, refer to the associated user manual interconnections.

*Analog I/O functionalities are available only with PROPixx full version (VPX-PRO-5001C)

Table 3 Analog I/O

Pin	Description	Pin	Description
1	ADC0	14	ADC1
2	ADC2	15	ADC3
3	ADC4	16	ADC5
4	ADC6	17	ADC7
5	ADC8	18	ADC9
6	ADC10	19	ADC11
7	ADC12	20	ADC13
8	ADC14	21	ADC15
9	REF0	22	REF1
10	GND	23	+5 VDC **
11	DAC0	24	DAC1
12	DAC2	25	DAC3
13	GND		Shield *

* Shield is tied to the GND by a 0 Ohm resistor inside the PROPixx controller.

** Current limited (400mA).

Connector type: D-SUB, 25 pins

Gender: Female



VESA 3D connector

Use this interface to connect your VESA 3D glasses. The following table shows the VESA 3D pin assignment.

Table 4 VESA 3D

Pin	Description
1	+5 VDC **
2	GND
3	VESA_LR (+5 VDC)
	Shield *

Connector type: Mini-DIN, 3 pins

Gender: Female

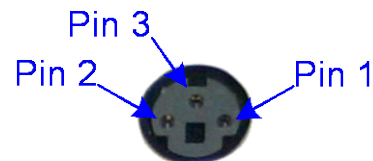

* Shield is tied to the GND by a 0 Ohm resistor inside the PROPixx controller.

** Current limited (400mA).

Digital output connector

The following table shows the digital output pin assignment.

Table 5 Digital Output

Pin	Description	Pin	Description
1	Digital Out 0	14	Digital Out 1
2	Digital Out 2	15	Digital Out 3
3	Digital Out 4	16	Digital Out 5
4	Digital Out 6	17	Digital Out 7
5	Digital Out 8	18	Digital Out 9
6	Digital Out 10	19	Digital Out 11
7	Digital Out 12	20	Digital Out 13
8	Digital Out 14	21	Digital Out 15
9	Digital Out 16	22	Digital Out 17
10	Digital Out 18	23	Digital Out 19
11	Digital Out 20	24	Digital Out 21
12	Digital Out 22	25	Digital Out 23
13	GND		Shield *

* Shield is tied to the GND by a 0 Ohm resistor inside the PROPixx controller.

Digital input connector

The following table shows the digital input pin assignment.

Table 6 Digital Input

Pin	Description	Pin	Description
1	Digital In 0	14	Digital In 1
2	Digital In 2	15	Digital In 3
3	Digital In 4	16	Digital In 5
4	Digital In 6	17	Digital In 7
5	Digital In 8	18	Digital In 9
6	Digital In 10	19	Digital In 11
7	Digital In 12	20	Digital In 13
8	Digital In 14	21	Digital In 15
9	Digital In 16	22	Digital In 17
10	Digital In 18	23	Digital In 19
11	Digital In 20	24	Digital In 21
12	Digital In 22	25	Digital In 23
13	GND		Shield *

* Shield is tied to the GND by a 0 Ohm resistor inside the PROPixx controller.

Connector type: D-SUB, 25 pins

Gender: Female



Connector type: D-SUB, 25 pins

Gender: Female



Audio In / MIC In / Audio Out

Audio equipment may be connected through these jacks with standard 1/8" (3.5 mm) stereo plugs. The following table shows the audio pin assignment for each jack.

*Audio IN, MIC In and Audio functionalities are available only with PROPixx full version (VPX-PRO-5001C)

Audio In

Table 7 Audio In

Pin	Description
TIP	Audio In left
Ring	Audio In Right
Sleeve	GND
Shield *	

Connector type: Stereo 1/8" (3.5 mm)

Gender: Jack (female)

* Shield is tied to the GND by a 0 Ohm resistor inside the PROPixx controller.

Audio Out

Table 8 Audio Out

Pin	Description
TIP	Audio Out left
Ring	Audio Out Right
Sleeve	GND
Shield *	

* Shield is tied to the GND by a 0 Ohm resistor inside the PROPixx controller.

MIC In

Table 9 MIC In

Pin	Description
TIP	MIC In left
Ring	MIC In Right
Sleeve	GND
Shield *	

* Shield is tied to the GND by a 0 Ohm resistor inside the PROPixx controller.

Theory of operation

Video Pipeline

A video signal contains all the pixels for every frame. The resolution determines the amount of pixels: for example, 1920 x 1080 means 1920*1080 pixels on your screen. Each of these pixels contains the color information it will show on screen.

Colors are described using the RGB (Red-Green-Blue) format. For every video frame, each pixel has access to 24 bits of color information (8 bits per color). This means, for example, that red can take values from 0 to 255 and consequently that 256 different shades of red are possible. Red 0 signifies no red, while red 255 signifies 100% red color. All of the three colors (RGB) have 8 bits, which creates 16 777 216 different possible colors. RGB colors are usually represented as (R,G,B), where R, G and B are the respective color values [0-255].

A color is usually described with 8 bits of information. 8-bit information can be seen as $R_7R_6R_5R_4R_3R_2R_1R_0$, which is a binary representation of the color (in this example, R for Red). Every bit (R_i) can take the value 0 or 1, and the final value will be a sum:

$$Red = \sum_{i=0}^{i=7} 2^i * R_i$$

The color red 255 would be represented as 0b11111111, whereas red 16 would be 0b00010000. Since 255 represents every bit at a value of 1, it is the maximum value for an 8-bit number.

Video and I/O synchronization

The PROPixx displays video information with no processing delay, and the I/O subsystems have microsecond-precise synchronization with the incoming video vertical sync pulse. The system waits until it has received a complete video frame, then presents all raster lines simultaneously (rather than being scanned from top to bottom) starting at about $t = 8.33$ ms in the case of a 120 Hz video refresh rate. In the case of 480 Hz stimulation, this fixed latency would drop to about 2.08 ms.

DVI Out

A second display can be connected to the DVI Out port. This secondary display can be used, for example, by a remote operator who wishes to monitor the stimuli being presented to a test subject.

Analog output interface

The PROPixx analog subsystem contains 4 DAC (Digital-to-Analog-Converter) channels, with 16-bit precision and ± 10 V output swing. The maximum update rate is 1 MSPS and all 4 channels update simultaneously. The DAC update rate can be specified in samples per second, samples per video frame, or nanoseconds per sample. Waveform onset can be synchronized to video refresh with microsecond precision.

Analog input interface

The PROPixx analog subsystem includes 16 ADC (Analog-to-Digital Converter) channels, with 16-bit precision and ± 10 V input range. The maximum sampling rate is 200 kSPS and all 16 channels are simultaneously sampled for evoked potential and other applications sensitive to the sampling phase. The ADC sample rate can be specified in samples per second, samples per video frame, or nanoseconds per sample. Sampling can be synchronized to video refresh with microsecond precision.

Digital interface

The PROPixx contains 24 TTL inputs and 24 TTL outputs. Inputs are pulled up, so simple response boxes can be read with no additional hardware. TTL input transitions are time-tagged to enable response time calculation with microsecond precision. Similarly, TTL outputs can be scheduled to transition at a specified point within a video frame, to enable simple triggering of external testing hardware.

Audio interface

The PROPixx contains a stereo audio CODEC which can bias and convert a stereo microphone input. The CODEC can also drive a 96 kSPS audio stimulus directly into headphones. Stimulus phase between audio-left, audio-right, and video refresh can be controlled with microsecond precision for cross-modal research.

LED light source

The PROPixx light engine uses 3 big chip LEDs that can deliver an enormous color gamut to the screens. The following CIE 1931 color space diagram shows the x-y color coordinates of the PROPixx LEDs. The peak wavelengths are Red: 623 nm, Green: 525 nm, Blue: 460 nm

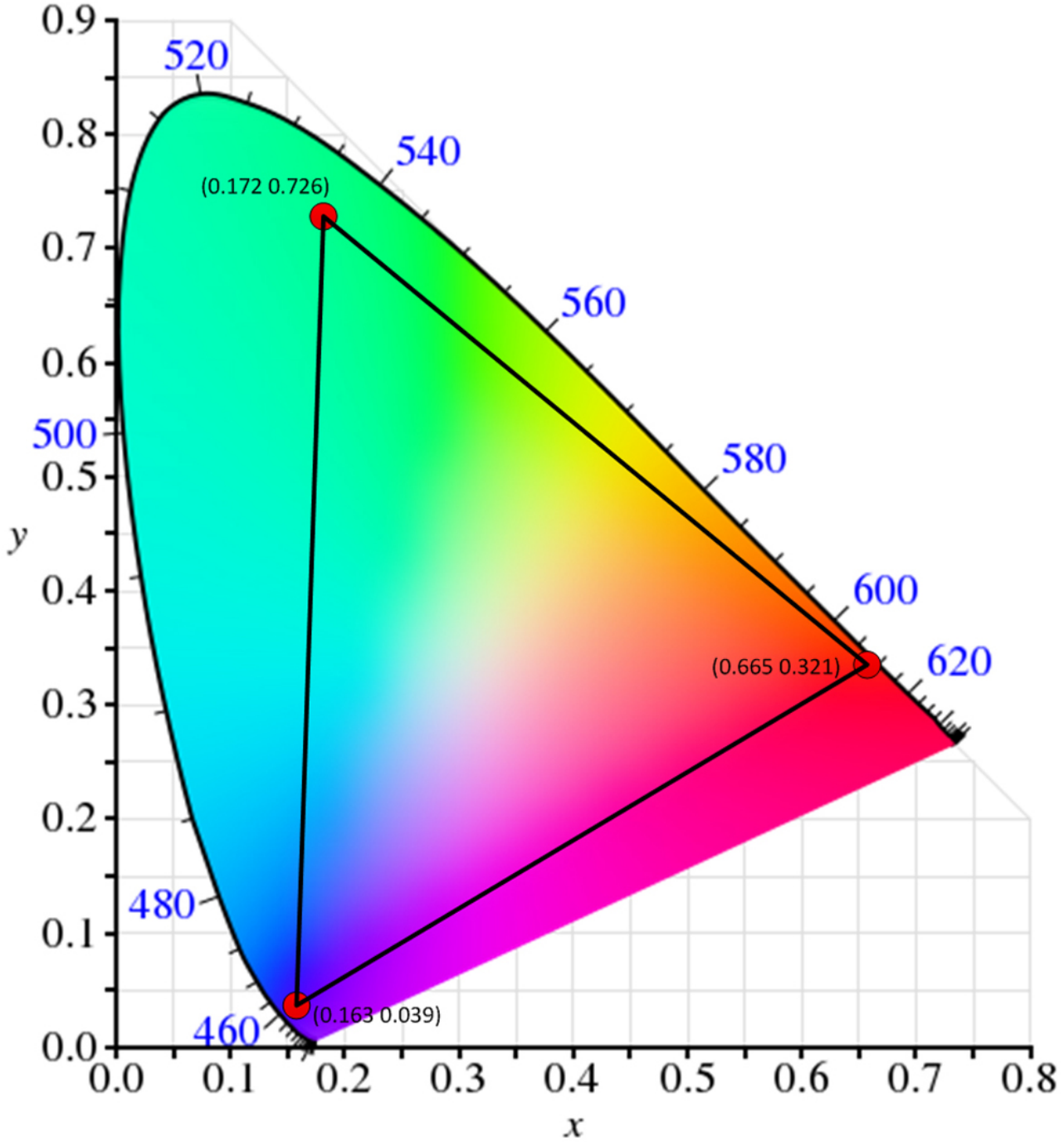

Figure 19 CIE 1931 Color Space Diagram

Software support

Your PROPixx display includes a full set of I/Os and can be accessed through the DATAPixx toolbox in our VPixx Software Tools libraries.

VPixx Software Tools include a low-level ANSI C API as well as Psychtoolbox MATLAB / Octave and Python libraries for Mac OS X, Windows XP, Windows 7, Windows 8 and Linux. In addition, the PROPixx is directly supported by the VPixx high-level application.

With the VPixx Software Tools, you can:

- Acquire data on analog IO;
- Acquire an analog signal and convert it to digital;
- Set up audio playback, feedback and stream;
- Set up voltage outputs, synchronize and generate audio using digital to analog convertors;
- Record, monitor and synchronize with a RESPONSEPixx or any digital signal;
- Set up a Gaze Contingent display using a DATAPixx;
- Show 3D Stimuli with perfect synchronization;
- Display stimuli using high-bit precision;
- Record a microphone input;
- Display stimuli at 440 and 1440 Hz using a PROPixx;
- Set up a touchscreen using a TOUCHPixx;
- And much more !

We strongly recommend you create your MyVPixx account by visiting:

<http://vpixx.com/register/>

By registering, you will have access to the latest software versions, demos and user manuals to support all your VPixx products.

Psychtoolbox

All PROPixx I/Os can be accessed through the DATAPixx toolbox library included with the Psychtoolbox. The DATAPixx hardware toolbox is fully supported by the Psychophysics Toolbox (PTB) using Matlab or GNU/Octave under OS X, Windows and Linux.

Once the PTB has been installed, there are several paths to getting information on using the DATAPixx within the PTB. From Mario Kleiner: "All special graphics display functions (stereo, multi-display, mirroring, high precision color and luminance display) are supported via PsychImaging, e.g., demonstrated in BitsPlusCSFDemo, AdditiveBlendingForLinearSuperpositionTutorial and ImagingStereoDemo. The Timestamping functionality and other convenience functions, as well as audio capture and voice keys are available via PsychDataPixx, DatapixxAudioKey and PsychPortAudioDatapixxTimingTest. Refer to the *Help* section of the DatapixxToolbox for more information.

All low-level features are supported via the Datapixx mex file driver". In addition, the DatapixxDemos folder contains a collection of low-level DATAPixx functional starting points for all of the basic functionalities.

DatapixxToolbox questions may be emailed to support@vpixx.com. General questions whose answers may be useful to other PROPixx or DATAPixx users should be posted on the PTB forum.



*For more information on PsycToolbox, please refer to the **DATAPixx Toolbox for MATLAB user manual** on MyVPixx.*

Python

pypixxlib uses the object-oriented approach and strengths of Python. With pypixxlib, you can get information to and from your devices while using your preferred python packages for stimulus generation. pypixxlib converts your physical device into python objects with attributes matching the subsystems included in VPixx devices. This guarantees everything you attempt is executed on the subsystem you intended. We also offer a functional approach with the versatility of Python; pypixxlib includes a wrapper for our ANSI C API.

Complete with full documentation and demos, pypixxlib is therefore very easy to use.



*For more information on Python, please refer to the **DATAPixx Toolbox for Python user manual** on MyVPixx.*

Low-level ANSI C API

Insert the CD labeled "**VPixx Technologies Software/Documentation**" in your CD/DVD reader and browse it. The "**Low Level C API\libdpx\src**" folder in the **Software** folder contains the ANSI C APIs, which are compatible with Windows, MAC OS X and Linux. Do not forget that I/Os are named as DATAPixx I/Os.



*For more information on low level ANSI C API, please refer to the **DATAPixx Toolbox low level ANSI C API user manual** on MyVPixx.*

PROPixx firmware update

For a firmware update, log on to your MyVPiXX account and select the proper software tools package for your operating system under the UPDATES tab.

For Windows :

Download and install the *setup.exe* application and follow the instructions. When finished, run the *vputil.exe* application located under the following path C:\Program Files\VPiXX Technologies\Software Tools\vputil\bin\win32\

At the command line prompt, type `fw_update`. Your PROPiXX will be updated with the latest firmware.

For MAC OS X or Linux :

Download the *VPiXX Software Tools package* and copy the *Software Tools for Mac* folder into the OS X or Linux user folder. When finished, run the *vputil.app* application located under the following path in your user folder: `VPiXX_Software_Tools/vputil/bin/macosx/`

At the command line prompt, type `fw_update`. Your PROPiXX will be updated with the latest firmware.



*For more information on firmware updates, please refer to the **VPiXX Software Tools user manual** on MyVPiXX.*

vputil Software Tool

The vputil tool can be run from the main VPixx Technologies directory under the “Software Tools\vputil\bin” folder. This utility allows the user to control some of the VPixx equipment features. It can also be used for generating built-in test patterns from the equipment.

1. Toggle the power switch to the ON position
2. Run the vputil application

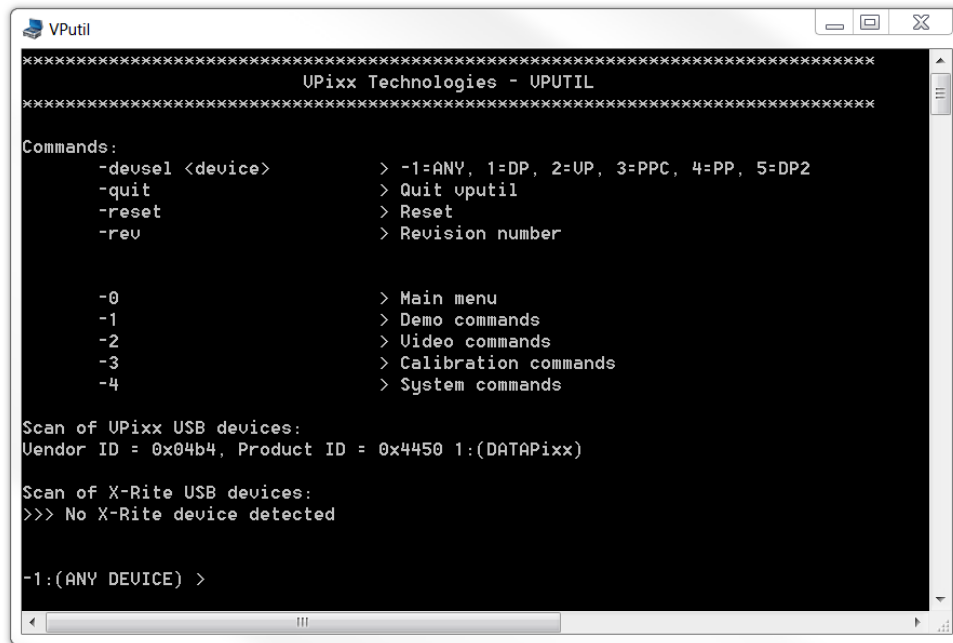

```
VPutil
UPixx Technologies - UPUTIL

Commands:
  -deusel <device>      > -1=ANY, 1=DP, 2=UP, 3=PPC, 4=PP, 5=DP2
  -quit                 > Quit vputil
  -reset                > Reset
  -rev                  > Revision number

  -0                    > Main menu
  -1                    > Demo commands
  -2                    > Video commands
  -3                    > Calibration commands
  -4                    > System commands

Scan of UPixx USB devices:
Vendor ID = 0x04b4, Product ID = 0x4450 1:(DATAPixx)

Scan of X-Rite USB devices:
>>> No X-Rite device detected

-1:(ANY DEVICE) >
```

Figure 20 vputil application main screen

The vputil tool automatically detects all VPixx Technologies hardware connected to the computer. The main menu of the application can be displayed by using the help command.



*For more information on vputil software tools, please refer to the **VPixx Software Tools user manual**.*

Maintenance and Calibration

Calibrating the PROPixx

Calibrating the PROPixx display requires the use of the X-Rite i1Display Pro.



*For more information on calibrating the PROPixx, please refer to the **VPixx Calibration user manual** on MyVPixx.*

Warranty

The PROPixx is warranted against manufacturing defects in materials and workmanship for two years for parts and labor from the date of purchase.



VPiXX Technologies Inc.

630 Clairevue West suite 301

Saint-Bruno, Qc

Canada, J3V 6B4

TEL/FAX: (514) 328-7499

TOLL FREE: (844) 488-7499 (USA/CANADA)

EMAIL: sales@VPiXX.com